

Products: AMIQ, SMIQ, FSP, FSU, FSE

Swept Adjacent Channel Power Analysis on Digital TV Amplifiers

Application Note

Adjacent Channel Power performance of power amplifiers used in digital TV systems has to be guaranteed over a wide frequency range, 54 to 890 MHz, which may lead to time consuming test procedures. The application software described here provides swept ACP analysis, using AMIQ and SMIQ for signal generation and FSP, FSU or FSE for signal analysis. ACP measurement is performed according to FCC Regulation 47CFR 73.622(h).



Contents

1	Overview.....	2
2	8 VSB Signal Generation.....	3
3	Creating an FCC Spectrum Mask with ACP parameter Settings	5
4	Software Features	7
5	Hardware and Software Requirements	7
	Hardware Requirements	7
	Software Requirements.....	7
6	Connecting the Instruments and the Computer/ Test Setup	8
	Connecting the instruments.....	8
	Setting GPIB addresses	8
	Connecting the computer	8
7	Installing the Software	9
8	Operating the Software.....	9
	Getting Started:	10
	Detailed Operation Description.....	10
9	Literature	15
10	Ordering information.....	15
11	Additional Information.....	15

1 Overview

Adjacent Channel Power performance of power amplifiers used in terrestrial digital TV antenna systems has to be guaranteed over a wide frequency range 54 to 890 MHz, which may lead to time consuming test procedures.

The application software here described provides a fast swept Adjacent Channel (ACP) analysis, using AMIQ and SMIQ for Signal generation and FSP/FSU or FSE for Signal Analysis. The software transfers an 8-VSB modulation file to the AMIQ. The AMIQ drives the I/Q Inputs of the SMIQ which is used in vector modulation mode. The SMIQ output drives the amplifier to be tested. The amplifier output is connected to the spectrum analyzer input. The ACP measurement is performed according to FCC Regulation 47CFR 73.622(h).

2 8 VSB Signal Generation

Vestigial side band modulation with 8 discrete amplitude levels (8 VSB) is the digital modulation technique recommended by the Advanced Television Systems Committee (ATSC) and adopted by the Federal Communications Commission (FCC) for terrestrial delivery of digital TV signals within the United States.

With 8 VSB modulation the lower sideband is suppressed. The resulting spectrum is flat except for the band edges where a nominal square root raised cosine response results in 620 kHz transition regions. The nominal VSB transmission spectrum is shown in Figure 1.

Instead of the carrier, a small pilot is added 310 kHz from the lower band edge whose power is nominally 11.3 dB below the average data signal power.

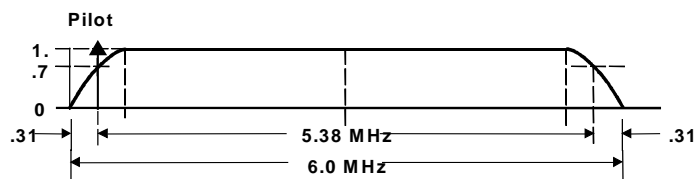

Fig. 1 8 VSB channel occupancy (nominal).

Within the application software a WINIQSIM file can be transferred to the AMIQ which simulates exactly the behavior of a nominal 8 VSB signal (There is no need to run WINIQSIM additionally).

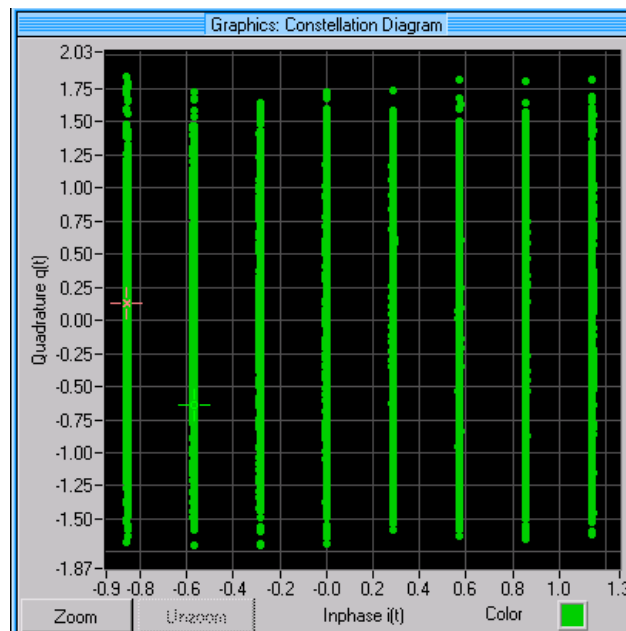

Fig. 2 Constellation diagram of 8 VSB Signal generated with AMIQ (Shown in WINIQSIM)

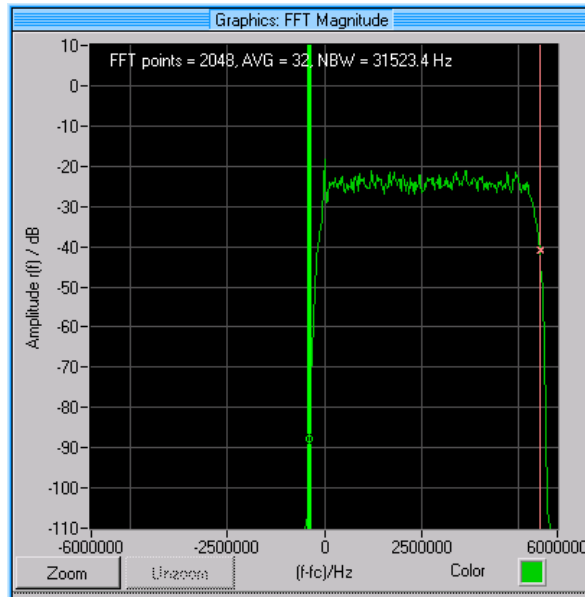

Fig. 3 FFT of 8 VSB Signal generated with AMIQ (shown with WINIQSIM)

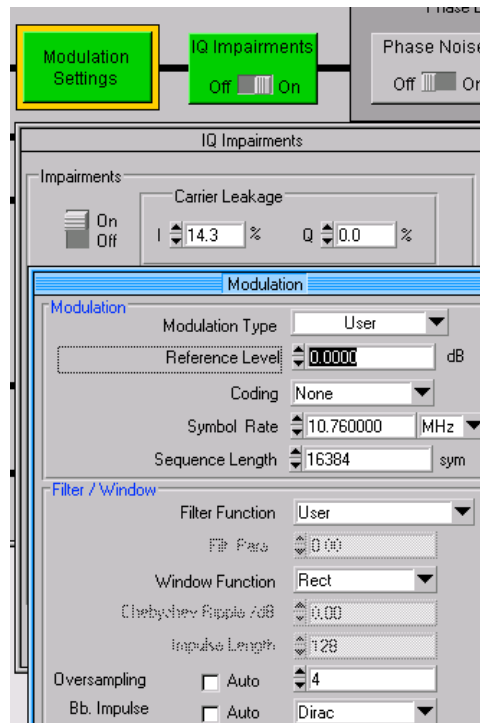

Fig. 4 Modulation- and IQ Impairment Setting of 8 VSB Signal generated with AMIQ

3 Creating an FCC Spectrum Mask with ACP parameter Settings

Outside the channel, the emissions are limited by the FCC regulations.

A graphical representation of the FCC DTV emission mask is shown in figure 5 below.

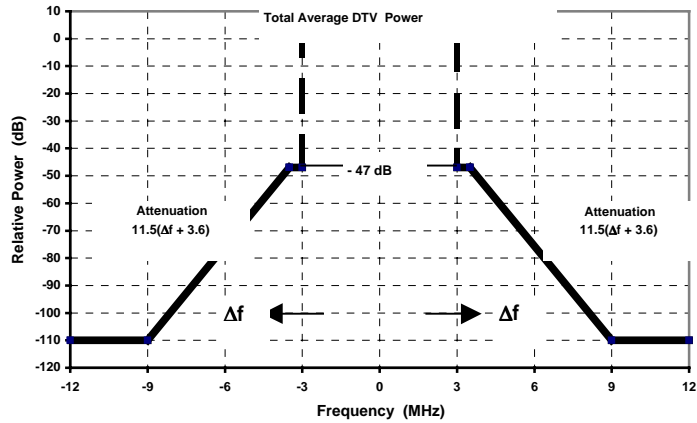

Fig. 5 The FCC DTV Emission Mask (based on measurement bandwidth of 500 kHz)

The spectrum mask within the carrier distance $F_o \pm 3$ MHz to $F_o \pm 3.5$ can easily be measured directly by the spectrum analyzers of the FSP, FSU or the FSE family.

The distant part of the spectrum mask required by the FCC cannot be met by any available power amplifier and or by any available spectrum analyzer. In reality a bandpass filter is used behind the amplifier to achieve the -110 dB/500 kHz.

Nevertheless a power amplifier used in DTV cable systems has to guarantee a minimum performance in the range. From the value measured at 6 MHz carrier distance the behavior including the filter can be extrapolated.

Swept ACP analysis on DTV amplifiers

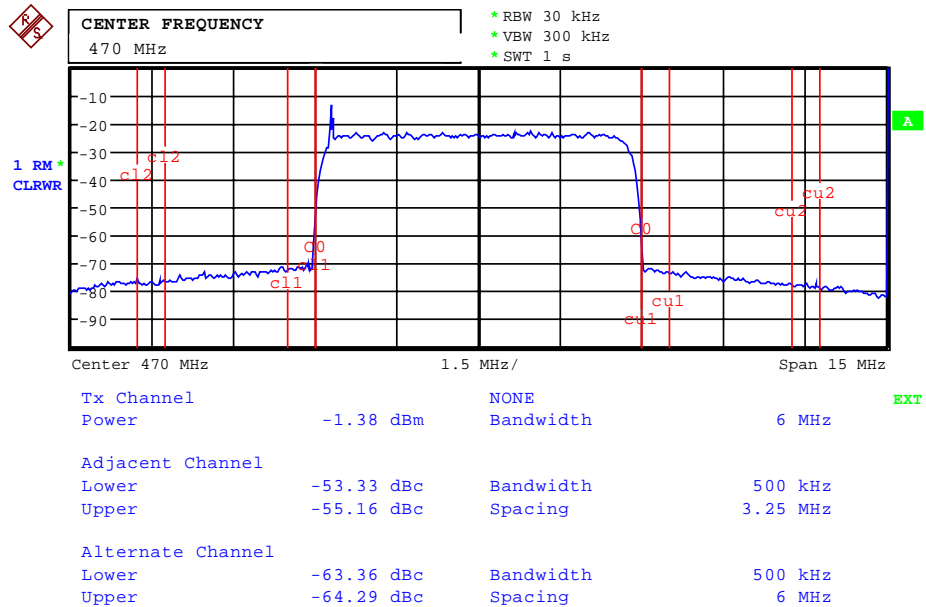

Fig. 6 FSP screen with ACP measurement to FCC Regulation 47CFR 73.622
The ACP measurement settings to FCC Regulation 47CFR 73.622 are:

- Channel Bandwidth (Main Channel): 6 MHz
- Adjacent and Alternate Channel Bandwidth: 500 kHz
- Channel Spacing Adjacent Channels: 3.25 MHz
- Channel Spacing Alternate Channels: 6 MHz
- Resolution bandwidth: 30 kHz

The resolution bandwidth (RBW) is set to 30 kHz to give sufficient selectivity. To achieve true power indication the RMS detector is set. The video bandwidth is set to 10 times the RBW to guarantee true RMS indication.

The reproducibility of measurement values (Channel Power, Adjacent Channel Powers and Alternate Channel Powers) is dependent on the sweep time which is settable in the software. A default value sweep time of 50 ms is chosen which allows fast measurement speed and a reproducibility of about 1 dB. Longer sweep times increase both reproducibility and measurement time.

4 Software Features

The software is installed on a separate PC and uses GPIB to control signal generation (AMIQ and SMIQ) and signal analysis (FSP, FSU, or FSE). An 8VSB waveform file is transmitted to AMIQ. The AMIQ I/Q outputs feed the SMIQ I/Q inputs. The SMIQ is set to vector modulation. The SMIQ output signal can be fed directly to the FSP, FSU or FSE (just to test the setup) or via a device under test (DUT) which is typically a power amplifier.

The swept ACP is measured step by step. Start-, stop- and step frequency define the frequency range and the number of measurements. A previously prepared frequency-/level list can also be used. A frequency-/level list is generated in learn mode using start-, stop and step frequency and the level at the analyzer as parameters. At every frequency the level of the generator will be adjusted so that the set analyzer level is met and all frequencies and the required generator levels are stored in a list.

Numerical results of channel power and the powers of upper and lower adjacent channels and first alternate channels at all measured frequencies are shown in the result window and can be printed or stored in a result file. Plots of the results on the screen or at the printer are possible as well.

5 Hardware and Software Requirements

Hardware Requirements

- CPU: Pentium or better
- RAM: 64 Mbytes or more
- Monitor: VGA colour monitor
- GPIB: National Instruments AT-GPIB/TNT

Software Requirements

- Windows 95/98 or Windows NT (Version 4.0 or better)
- GPIB-Driver

6 Connecting the Instruments and the Computer/ Test Setup

Connecting the instruments

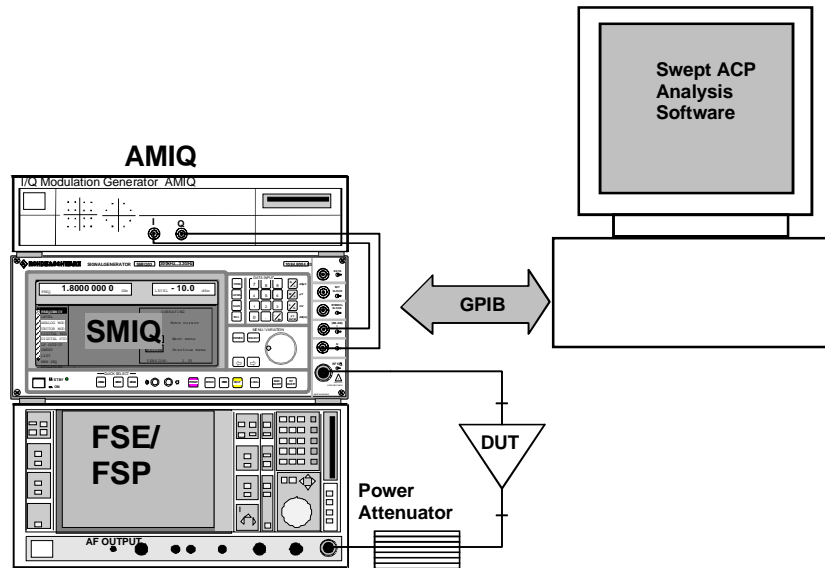

Setting GPIB addresses

AMIQ: address 6

SMIQ: address 28

FSP, FSU or FSE: address 20

Connecting the computer

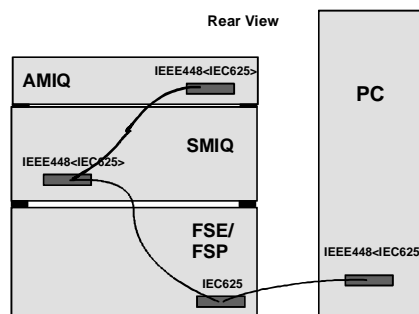

7 Installing the Software

The Microsoft Installer is used to install the Swept ACP Analysis program.

If the Microsoft Installer is already installed you can start Swept_ACP_Analysis.MSI directly without running the InstMsi- files.

Windows 95/98: Copy InstMsiA.exe and Swept_ACP_Analysis.MSI to a directory.

Windows NT: Copy InstMsiW.exe and Swept_ACP_Analysis.MSI to a directory.

Installation procedure:

1. Windows 95/98: Run **InstMsiA.exe**
Windows NT: Run **InstMsiW.exe**
2. Run Swept_ACP_Analysis.MSI and follow the instructions on the screen.

8 Operating the Software

The picture below shows the opening screen:

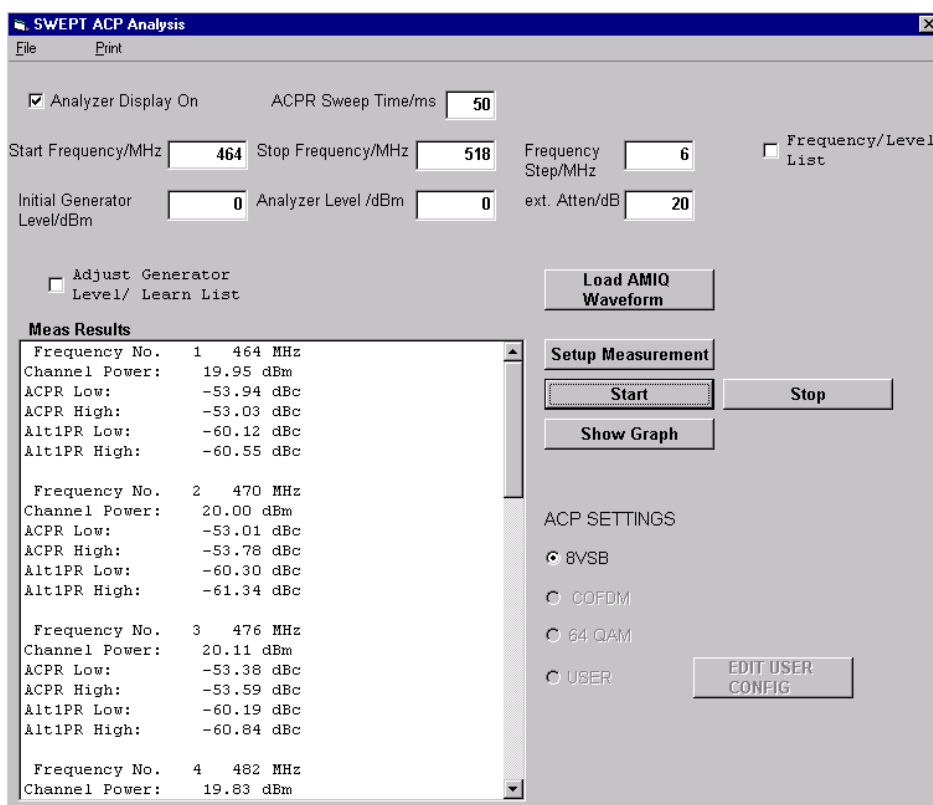

Getting Started:

1. Set the *Start Frequency/MHz* to the required value (click in the Start Frequency Window and enter the value)
2. Set the *Stop Frequency/MHz* to the required value
3. Set the *Frequency Step/MHz* to the required value
4. Set the *External Attenuation/dB*
(Maximum safe input power for the FSE/P: +30 dBm)
5. Choose *ACP Sweep Time* (recommended minimum sweep time: 20 ms)
6. Set *Initial Generator* level to an appropriate value (Analyzer Level + external Attenuation – DUT gain)

Example:

Gain of DUT = 30 dB,

external Attenuation = 20 dB

Analyzer Level = 10 dBm

→ *Initial Generator Level* = 10 dBm + 20 dB – 30 dB = 0 dBm

7. Set the *Analyzer Level* to an appropriate value (Output level of DUT – external Attenuation)

Example:

DUT output Level = 30 dBm

external Attenuation = 20 dB

→ *Analyzer Level* = 30 dBm – 20 dB = 10 dBm

8. Click on *Load AMIQ Waveform* to initialize AMIQ
9. Click on *Setup measurement* to initialize the generator and analyzer
10. Click on *Start Measurement* to start measurement

Detailed Operation Description

- Analyzer Display On

To increase measurement speed switch off the display. Default setting is *Analyzer Display On*.

- ACPR Sweep Time/ms

2. Set the analyzer sweep time in the *ACP Sweep Time/ms* field. Higher sweep times slow measurement speed but increase measurement result reproducibility.

- Setting the frequency parameters:

Start Frequency/MHz Stop Frequency/MHz Frequency Step/MHz Frequency/Level List

Set the frequency with *Start Frequency/MHz*, *Stop Frequency/MHz* and *Frequency Step/MHz*. Alternatively a previously defined frequency-/level list can be used (click to *Frequency-/Level List*).

Swept ACP analysis on DTV amplifiers

Initial Generator Level/dBm Analyzer Level /dBm

Adjust Generator Level/ Learn List

Set the initial generator level. If *Adjust Generator Level/ Learn List* is set the software adjusts the generator level to match the analyzer level. A frequency/level list is created (filename: TestFrequencyList.txt) which can be loaded by clicking on *Setup measurement*.

Example of a Frequency-/Level list:

Frequencies (left) are in MHz, levels (right) are in dBm.

Frequency (MHz)	Level (dBm)
464	9.148584
470	8.995651
476	8.991998
482	9.450561
488	8.860897
494	9.292846
500	9.059812
506	8.642087
512	9.253545
518	9.058607

ext. Atten/dB

To take an external attenuator into account (in front of the analyzer input) enter a value as *ext. Atten/dB*. The values for channel power in the result field will be corrected.

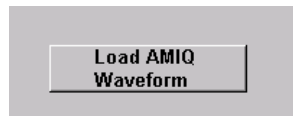

Click on *Load AMIQ Waveform* to load and activate a 8VSB waveform setup by AMIQ.

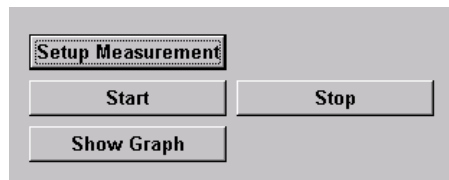

- Click *Setup Measurement* to set values for configuring SMIQ and FSE(FSP). Start a measurement sequence with *Start*.
- Click *Start* to begin measurement sequence.
- Stop and close the software with *Stop*.

After finishing the measurement sequence, frequencies of measurement, channel powers, and the powers in the adjacent and First alternate channels are shown in the result field. To scroll results use the scroll bar.

Swept ACP analysis on DTV amplifiers

Meas Results	
Frequency No.	1 464 MHz
Channel Power:	11.05 dBm
ACPR Low:	-50.64 dBc
ACPR High:	-58.84 dBc
Alt1PR Low:	-35.76 dBc
Alt1PR High:	-63.22 dBc
Frequency No.	2 470 MHz
Channel Power:	10.78 dBm
ACPR Low:	-50.11 dBc
ACPR High:	-60.40 dBc
Alt1PR Low:	-35.78 dBc
Alt1PR High:	-62.98 dBc
Frequency No.	3 476 MHz
Channel Power:	10.87 dBm
ACPR Low:	-50.32 dBc

- With *Show Graphic* there is a graphic output of the results to the screen.

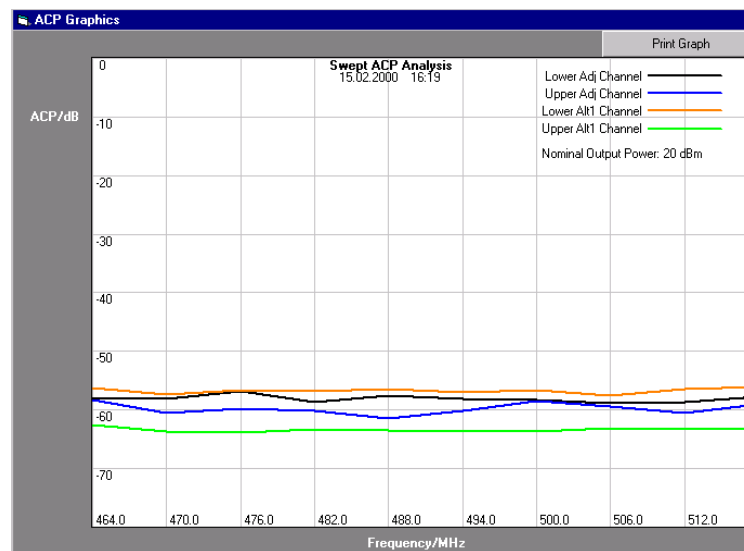

- Print the graph with *Print Graph* on the current Windows printer.



With ACP Settings as 8VSB the following ACP configuration is set in the analyzer:

No. Of adjacent channels: 2

Channel bandwidth: 6 MHz

Adjacent (alternate) channel bandwidths: 500 kHz

Adjacent channel spacing: 3.25 MHz

Alt 1 channel spacing: 6 MHz

Resolution bandwidth: 30 kHz

Video bandwidth: 300 kHz

Detector: RMS

Swept ACP analysis on DTV amplifiers

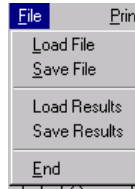

To reload a measurement configuration stored with *Save File* select *Load File* (file name: File.txt).

Example File:

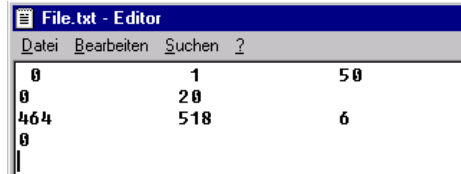

Format (Dependent whether List mode or not):

< list yes/No> <analyzer display yes/no> <sweep time/ms>
<analyzer level/dBm> <external attenuation/dB>

Case: No List

<start frequency/MHz> <stop frequency/MHz> <frequency step/MHz>
<Initial Generator Level in dBm>

Case: List

<number of frequencies>
<frequency 1> <level1>
<frequency 2> <level 2>

.....
.....

Explanation: 1=yes, 0=no List

To load a stored measurement result (stored with *Save Results*, file name: *ResultList.txt*), click *Load Results*.

Example of a ResultList.txt file:

```
10
464
20.520735025406
-54.3580458164
-53.0021421909
-59.6833059788
-61.15775132189
470
19.866267353296
-53.3140899241
-52.5315009654
-58.5820571482
-60.6074210703
476
20.308932036161
-52.7678477466
-51.6992938221
-59.4337527454
-60.10489913821
482
.....
.....
```

Explanation of file format:

1. Number of test frequencies
2. Test frequency 1 in MHz
3. Channel Power in dBm
4. Lower adjacent channel power in dBm
5. Higher adjacent channel power in dBm
6. Lower 1. Alternate channel power
7. Higher 1. Alternate channel power
8. Test frequency 2 in MHz

```
.....
.....
```

- Stop the program with *STOP*.



Print the current results by clicking *Print Results*.

9 Literature

- ATSC Digital Transmission Standard Revision A
- FCC Regulation 47 CFR 73.633(h)
- Gumm, Linley: Measurement of 8-VSB Transmitter Emissions (Revised)

10 Ordering information

Spectrum Analyzer		
FSP3	(9 kHz to 3 GHz)	1093.4495.03
FSP7	(9 kHz to 7 GHz)	1093.4495.07
FSP13	(9kHz to 13.6 GHz)	1093.4495.07
FSP30	(9 kHz to 30 GHz)	1093.4495.30
FSU3	(20 Hz to 3.6 GHz)	1129.9003.03
FSU8	(20 Hz to 8 GHz)	1129.9003.08
FSEA20	(9 kHz to 3.5 GHz)	1065.6000.20
FSEA30	(20 Hz to 3.5 GHz)	1065.6000.30
FSEB20	(9 kHz to 7 GHz)	1066.3010.20
FSEB30	(20 Hz to 7GHz)	1066.3010.30
FSEK20	(9 kHz to 40 GHz)	1088.1491.20
FSEK30	(20 Hz to 40 GHz)	1088.3494.30
FSEM20	(9 kHz to 26.5 GHz)	1080.1505.20
FSEM30	(20 Hz to 26.5 GHz)	1079.8500.30
Vector Signal Generator		
SMIQ02B	300 kHz to 2.2 GHz	1125.5555.02
SMIQ03B	300 kHz to 3:3 GHz	1125.5555.03
SMIQ04B	300 kHz to 4:4 GHz	1125.5555.04
SMIQ06B	300 kHz to 6:4 GHz	1125.5555.06
I/Q-Modulation Generator		
AMIQ03 incl. WinIQSIM™	4 MSamples Memory	1110.2003.03
AMIQ04 incl. WinIQSIM™	16 MSamples Memory	1110.2003.04
I-Q Simulation Software		
WINIQSIM™		(delivered with AMIQ)

11 Additional Information

Please contact **TM-Applications@rsd.rohde-schwarz.com** for comments and further suggestions.



ROHDE & SCHWARZ GmbH & Co. KG · Mühldorfstraße 15 · D-81671 München · P.O.B 80 14 69 · D-81614 München ·
Telephone +49 89 4129 -0 · Fax +49 89 4129 - 13777 · Internet: <http://www.rohde-schwarz.com>

This application note and the supplied programs may only be used subject to the conditions of use set forth in the download area of the Rohde & Schwarz website.